

FEATURES

- EIA STANDARD SIZING 0603 (1/8W), 0805 (1/4W), 1206 (1/2W), 2010 (1W) AND 2512 (2W)
- VOLTAGE RATINGS (50VDC ~ 300VDC)
- RESISTANCE VALUES (0Ω TO 1MΩ)
- THICK FILM ON ALUMINA SUBSTRATE, RuO₂/Ag RESISTIVE LAYER
- GLASS AND EPOXY OVERCOAT

NEW
High Power
Resistors
(Up to 2Watt)



Type	EIA Size	Power Rating at 70°C	Max.*1 Working Voltage	Max.*2 Overload Voltage	Resistance Tolerance (Code)	Temperature Coefficient (ppm/°C) +20°C ~ +155°C	Resistance Range (Ω)	Resistance Value	Operating Temperature Range (°C)
NRCW06	0603	1/8W (0.125W)	50V	100V	±1% (F) ±5% (J)	±100	1.0 ~ 1M	E-24,E-96	-55 ~ +155
NRCW10	0805	1/4W (0.25W)	150V	300V	±1% (F) ±5% (J)	±100	1.0 ~ 1M	E-24,E-96	
NRCW12	1206	1/2W (0.50W)	200V	400V	±1% (F) ±5% (J)	±100	1.0 ~ 1M	E-24,E-96	
NRCW50	2010	1W	200V	400V	±1% (F) ±5% (J)	±100	1.0 ~ 1M	E-24,E-96	
NRCW100	2512	2W	300V	500V	±1% (F) ±5% (J)	±100	1.0 ~ 1M	E-24,E-96	

Note *1 - Maximum allowable continuous Working Voltage for all resistors is the lower of the two values: "Maximum Working Voltage" as specified above (or)

$$\sqrt{\text{Power rating (Watts)} \times \text{Resistance (Ohms)}}$$

Note *2 - Maximum allowable Overload voltage is two times the Maximum Working Voltage (see Note *1 above).

Power Derating Curve: For operation above 70°C, power rating must be derated according to the following chart:

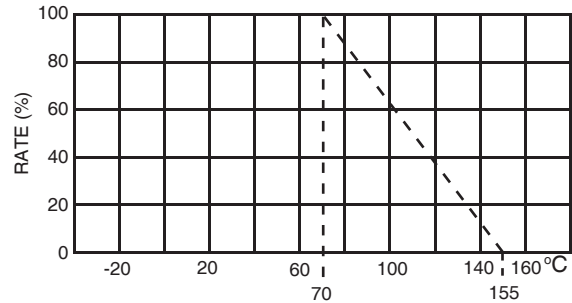

ZERO OHM PART NUMBERS AND SPECIFICATIONS

Part Numbers*	EIA Size	Rated Current (A)	Peak Current (A)	Max. Resistance (mΩ)	Operating Temperature Range (°C)
NRCW06ZOTRF	0603	2.0	5.0	20	-55 ~ +155
NRCW10ZOTRF	0805	4.0	10	20	
NRCW12ZOTRF	1206	5.0	12.5	20	
NRCW50ZOTRF	2010	7.0	17.5	20	
NRCW100ZOTRF	2512	10	25	20	

* See page 5 for optional reel sizes/quantities on 0603 and 0805 case sizes.

PART NUMBER SYSTEM (5% Tol. E-24 VALUES)

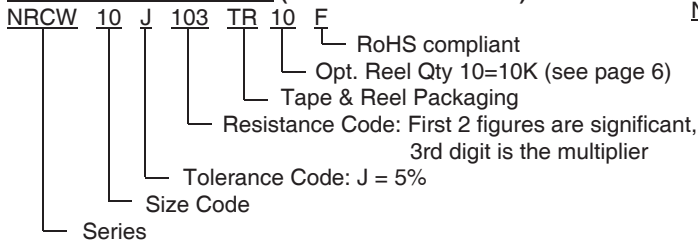

PART NUMBER SYSTEM (1% Tol. E-24 & E96 VALUES)

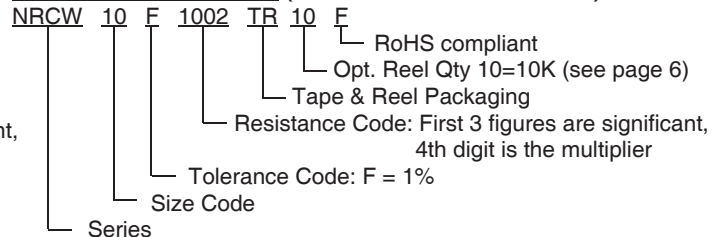

ENVIRONMENTAL CHARACTERISTICS

Item	Specification			Test Method
	Tol. 1%	Tol. 5%	0Ω	
Short Time Overload	$\Delta R \pm(1\% + 0.05\Omega)$	$\Delta R \pm(2\% + 0.05\Omega)$	20mΩ max.	JIS-C-5201-1 4.13 5x rated power or max overloading voltage whichever is less for 5 Seconds
Insulation Resistance	>10,000MΩ			JIS-C-5201-1 4.6 Maximum overload voltage for 1 minute
Endurance (Load Life)	$\Delta R \pm(1\% + 0.05\Omega)$	$\Delta R \pm(3\% + 0.1\Omega)$	20mΩ max.	JIS-C-5201-1 4.25 RCWV +70°C, 1.5 hours "ON", 0.5 hours "OFF" Total time 1,000 hours
Damp Heat with Load	$\Delta R \pm(1\% + 0.05\Omega)$	$\Delta R \pm(3\% + 0.1\Omega)$	20mΩ max.	JIS-C-5201-1 4.24 RCWV +40°C, 90~95% RH, 1.5 hour "ON", 0.5 hours "OFF" Total time 1,000 hours
Bending Strength	$\Delta R \pm(0.5\% + 0.05\Omega)$	$\Delta R \pm(1\% + 0.1\Omega)$	20mΩ max.	JIS-C-5201-1 4.33 Bend once for 10 seconds (0603 ~ 1206: 3mm, 2010, 2512: 2mm)
Solderability	>95% minimum coverage			JIS-C-5201-1 4.17 235°C ± 5°C for 2 ± 0.5 seconds
Resistance to Soldering Heat	$\Delta R \pm(0.5\% + 0.05\Omega)$	$\Delta R \pm(1\% + 0.1\Omega)$	20mΩ max.	JIS-C-5201-1 4.18 260°C ± 5°C for 10 seconds
Withstanding Voltage	No breakdown or flashover		20mΩ max.	JIS-C-5201-1 4.7 maximum overload voltage (AC) for 1 minute
Temperature Cycling	$\Delta R \pm(0.5\% + 0.05\Omega)$	$\Delta R \pm(1\% + 0.1\Omega)$	20mΩ max.	JIS-C-5201-1 4.19 30 minutes -55°C, 2 ~ 3 minutes +20°C, 30 minutes @155°C, 2 ~ 3 minutes +20°C (5 cycles)

COMPONENT DIMENSIONS (mm)*

Type	EIA Size	L	W	H	T	t
NRCW06	0603	1.60 ± 0.10	0.80 ± 0.10	0.45 ± 0.15	0.30 ± 0.15	0.30 ± 0.10
NRCW10	0805	2.00 ± 0.10	1.25 ± 0.10	0.50 ± 0.15	0.40 ± 0.20	0.40 ± 0.20
NRCW12	1206	3.10 ± 0.15	1.60 ± 0.15	0.55 ± 0.10	0.50 ± 0.25	0.50 ± 0.25
NRCW50	2010	5.00 ± 0.20	2.50 ± 0.20	0.60 ± 0.10	0.60 ± 0.25	0.60 ± 0.25
NRCW100	2512	6.30 ± 0.20	3.10 ± 0.20	0.60 ± 0.15	0.60 ± 0.25	1.80 ± 0.25

*Same for Zero Ohm Jumper

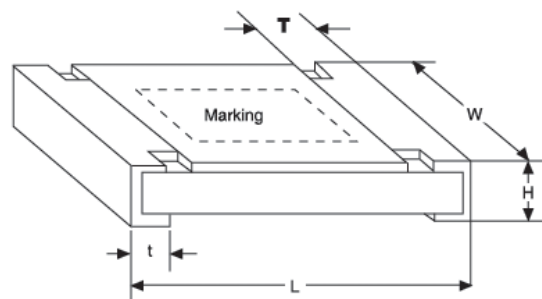

CONSTRUCTION

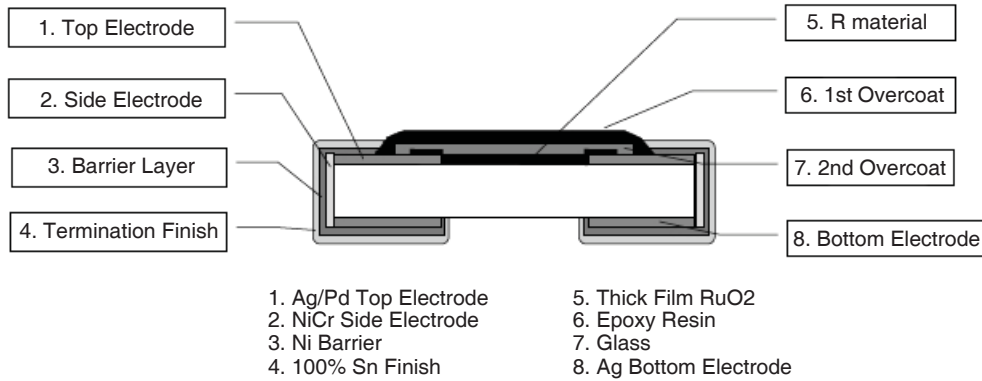

LAND PATTERN DIMENSIONS (mm)

Type	EIA Size	A	B	C
NRCW06	0603	0.90	0.60	0.90
NRCW10	0805	1.20	0.70	1.30
NRCW12	1206	2.00	0.90	1.60
NRCW50	2010	3.80	0.90	2.80
NRCW100	2512	3.80	1.60	3.50

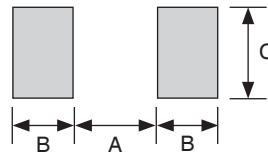

REFLOW SOLDERING TEMPERATURE PROFILE

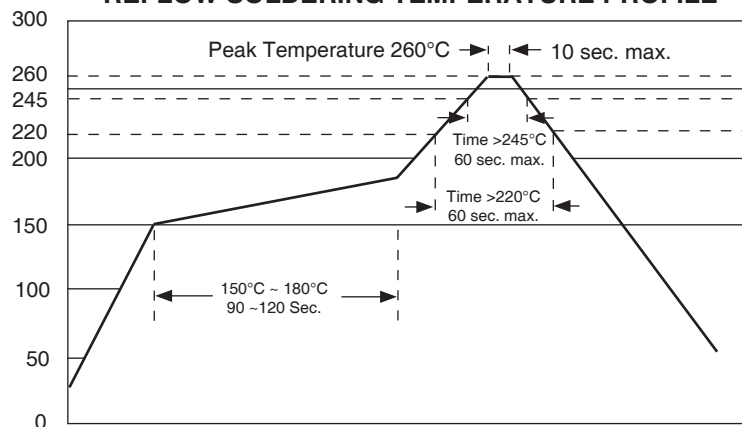

COMPONENT MARKING (Note: no marking on 0402 case size parts).

1. For **E-24** Series J ($\pm 5\%$) Tolerance In 0603, 0805, 1206, 2010 and 2512 sizes: _

3 DIGIT SYSTEM - First two digits are significant and third digit is multiplier

Examples: 100 = 10 ohms 101 = 100 ohms 102 = 1,000 103 = 10,000 ohms 104 = 100,000 ohms
105 = 1,000,000 ohms

2. For **E-96** Series F ($\pm 1\%$) Tolerance in 0805, 1206 and 2010 and 2512 sizes:

4 DIGIT SYSTEM - First 3 digits are significant and fourth digit is multiplier, "R" represents decimal point

Examples: 10R0 = 10 ohms 1000 = 100 ohms 1001 = 1,000 ohms 1002 = 10,000 1003 = 100,000 ohms
1004 = 1,000,000 ohms

3. For **E-96** Series F ($\pm 1\%$) Tolerance in 0603 size (available from 1.0 ohm ~ 1.0Mohm)

Special 3 DIGIT SYSTEM below (Due to space restrictions)

0603 E-96 VALUES 1% TOLERANCE RESISTANCE CODE

E-96									
Value	Code	Value	Code	Value	Code	Value	Code	Value	Code
100	01	102	02	105	03	107	04	110	05
110	05	113	06	115	07	118	08	121	09
121	09	124	10	127	11	130	12	133	13
133	13	137	14	140	15	143	16	147	17
147	17	150	18	154	19	158	20	162	21
162	21	165	22	169	23	174	24	178	25
178	25	182	26	187	27	191	28	196	29
196	29	200	30	205	31	210	32	215	33
215	33	221	34	226	35	232	36	237	37
237	37	243	38	249	39	255	40	261	41
261	41	267	42	274	43	280	44	287	45
287	45	294	46	301	47	309	48	316	49
316	49	324	50	332	51	340	52	348	53
348	53	357	54	365	55	374	56	383	57
383	57	392	58	402	59	412	60	422	61
422	61	432	62	442	63	453	64	464	65
464	65	475	66	487	67	499	68	511	69
511	69	523	70	536	71	549	72	562	73
562	73	576	74	590	75	604	76	619	77
619	77	634	78	649	79	665	80	681	81
681	81	698	82	715	83	732	84	750	85
750	85	768	86	787	87	806	88	825	89
825	89	845	90	866	91	887	92	909	93
909	93	931	94	953	95	976	96		

MULTIPLIER CODE

Code	A	B,b	C	D,d	E	F	G	H	X	Y	Z
Multiplier	10 ⁰	10 ¹	10 ²	10 ³	10 ⁴	10 ⁵	10 ⁶	10 ⁷	10 ⁻¹	10 ⁻²	10 ⁻³

CODING FORMULA

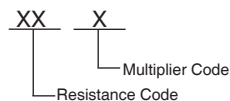

Example: $10.2k\Omega = \frac{102}{02} \times \frac{10^2}{C} \Omega = 02C$

$33.2 \Omega = \frac{332}{51} \times \frac{10^{-1}}{X} = 51X$

MARKING EXAMPLES

- 10 Ω = 01X
- 7.5K Ω = 85B or 85b
- 150K Ω = 18D or 18d
- 1.0Meg Ω = 01E



PUNCHED TAPING SPECIFICATIONS REEL QUANTITIES

Type	EIA Size	Carrier Tape			Qty per 7" Reel	Qty per 10" Reel	Qty per 13" Reel
		Fig.	Material	Width (mm)			
NRCW06	0603	A	Paper	8	5,000	10,000	20,000
NRCW10	0805	A	Paper	8	5,000	10,000	20,000
NRCW12	1206	A	Paper	8	5,000	N/A	N/A

CARRIER DIMENSIONS (mm)

Type	EIA Size	A	B	D	E	F	P ₀	P ₁	T	W
NRCW06	0603	1.10 ± 0.20	1.90 ± 0.20	1.5 ^{+0.1} / ₀	1.75 ± 0.1	3.5 ± 0.2	4.0 ± 0.1	4.0 ± 0.1	0.65 ± 0.05	8.0 ± 0.3
NRCW10	0805	1.65 ± 0.20	2.40 ± 0.20						1.0 max.	
NRCW12	1206	2.00 ± 0.10	3.60 ± 0.20							

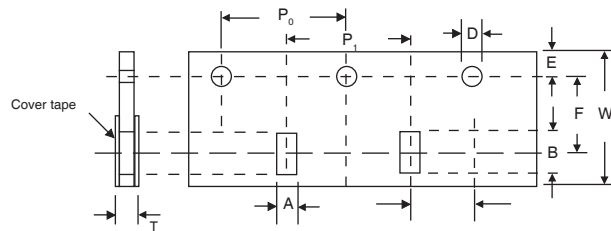

EMBOSSED PLASTIC TAPE SPECIFICATION REEL QUANTITIES AND CARRIER DIMENSIONS (mm)

Type	EIA Size	A	B	φD	E	F	P ₀	P ₁	T	W	Qty per Reel
											7" Reel
NRCW50	2010	2.80 ± 0.20	5.50 ± 0.20	1.5 ^{+0.1} / ₀	1.75 ± 0.1	5.5 ± 0.1	4.0 ± 0.1	4.0 ± 0.1	1.2 max.	12.0 ± 0.1	4,000
NRCW100	2512	3.60 ± 0.20	6.90 ± 0.20								

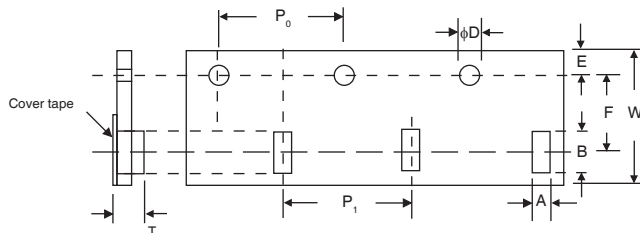

REEL SPECIFICATIONS

Type	Reel Diameter		ϕB (mm)	C (mm)	W (mm)	Reel Qty	Part Number Suffix
	ϕA						
NRCW06	7"	$\phi 178 \pm 2.0$	$\phi 60 \pm 1.0$	13.0 ± 0.2	9.0 ± 0.5	5,000	TRF
NRCW10	10"	$\phi 254 \pm 2.0$	$\phi 100 \pm 1.0$			10,000	TR10F
NRCW12	13"	$\phi 330 \pm 2.0$				20,000	TR20F
NRCW50	7"	$\phi 178 \pm 2.0$	$\phi 60 \pm 1.0$		12.4 ± 1.0	4,000	TRF
NRCW100						4,000	TRF

